









**MEM Salida en cascada para bañera sin inversor para montaje sobre encimera
- Platino cepillado**

MEM

13 630 740



- Saliente 235 mm
- Cascada
- Altura máxima del conjunto 100 mm
- Altura hasta el aireador 80 mm
- Diámetro del orificio 32 mm
- Racor 1/2"
- Caudal máx. 26,5 l/min con 3 bares de presión hidráulica

	Platino cepillado	13 630 740-06
	Cromo	13 630 740-00
	Platino	13 630 740-08
	Dark Chrome	13 630 740-19
	Latón cepillado (Oro 23k)	13 630 740-28
	Champagne cepillado (Oro 22k)	13 630 740-46
	Champagne (Oro 22k)	13 630 740-47
	Dark Platinum cepillado	13 630 740-99

13 630 740
mm [inches]



Diagrama de flujo



Diagrama de trayectoria

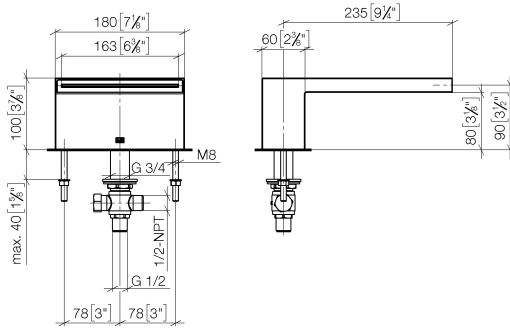
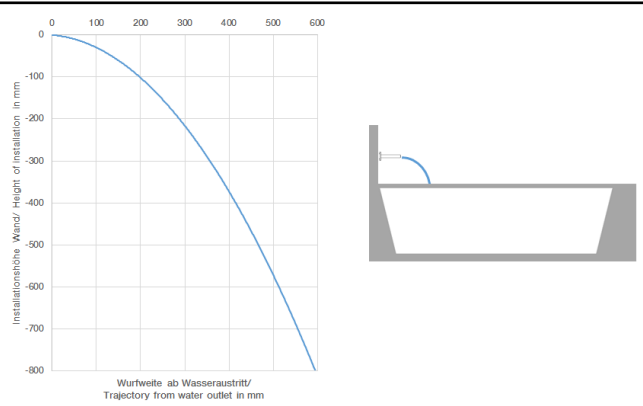

Certificado

IAPMO_4976 (6). LGA_19257. WRAS_1809016.

13 630 740

Piezas para otros acabados pueden encontrarse aquí:
Cromo

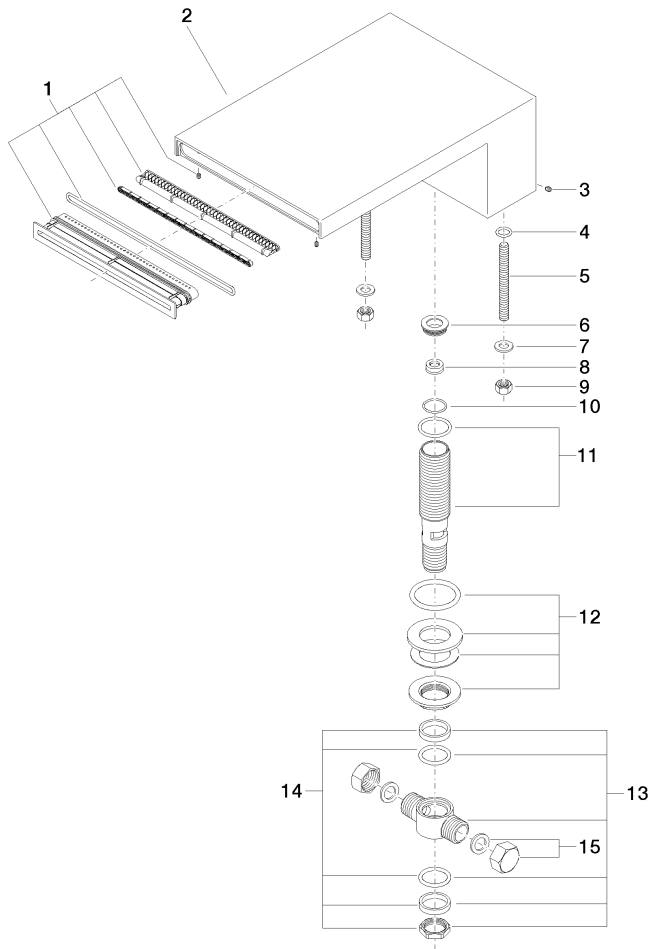

Lista de piezas de recambios

N°	Número de artículo	Denominación	Cantidad de montaje	Plazo de entrega
1	90 29 03 059 00 90	elemento insertable	1	2
2	09 11 74 040-06	caño	1	10
3	09 31 11 044 90	varilla	1	2
4	09 14 10 008 90	sello	2	2
5	09 31 11 011 90	varilla	2	2
6	09 24 04 246 20 90	boquilla	1	2
7	09 30 11 045 90	disco	2	2
8	09 23 01 057 90	limitador de caudal	1	2
9	09 23 10 023 90	tuerca	2	2
10	09 14 10 140 90	sello	1	2
11	90 30 01 033 00 90	alojamiento	1	2
12	04 23 10 004 04 90	juego de fijación	1	2
13	90 17 11 020 10 90	distribuidor	1	2
14	90 23 10 012 00 90	kit de la junta	1	2
15	04 21 02 006 00 92	caperuza	2	2